

GCC

Elite Glass Solutions

170 Derrimut Drive
Derrimut VIC 3026

7 Manfull Street
Melrose Park SA 5039

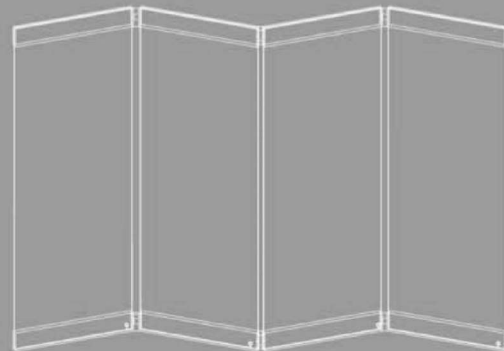

**HEAVY DUTY
SLIDING AND
FOLDING WALL SYSTEM**

NO BOTTOM GUIDE REQUIRED!

1300 4 ELITE



HEAVY DUTY
SLIDING AND
FOLDING WALL SYSTEM

System's benefits and advantages

1. No holes in the glass panel are required for the glass to fit this system.
2. With this system you don't need to install a bottom track or guide, as it requires minimal effort to fold/retract the glass panels via the top track only.
3. When glass door panels are folded back and retracted, they take up minimal space only 55mm between each glass panels.
4. This system has a modern anodized aluminum profile with a sleek and contemporary hinge system for today's market.

Applications:

- Automobile Showroom
- Banquet Halls
- Convention Centres
- Retail And Mall Storefronts
- Restaurants And Eateries.
- Commercial and Domestic room division

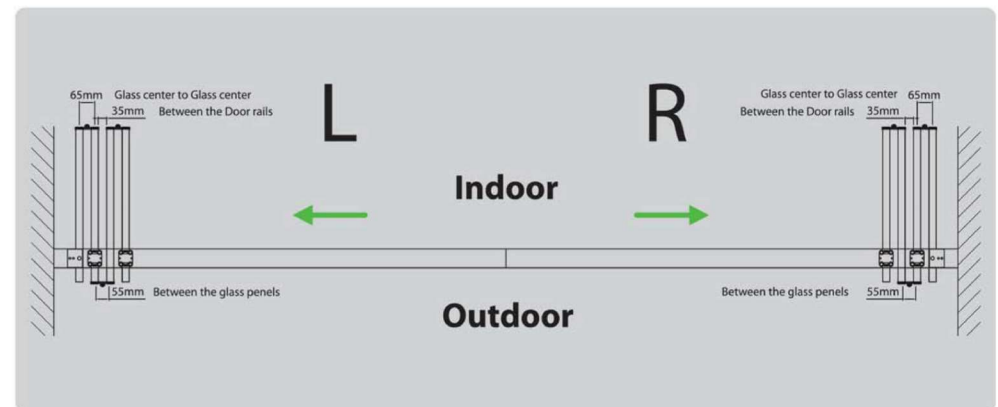

Type A1 Rollers Offset Type

Type A2

Rollers Offset Type with last free single swing panel

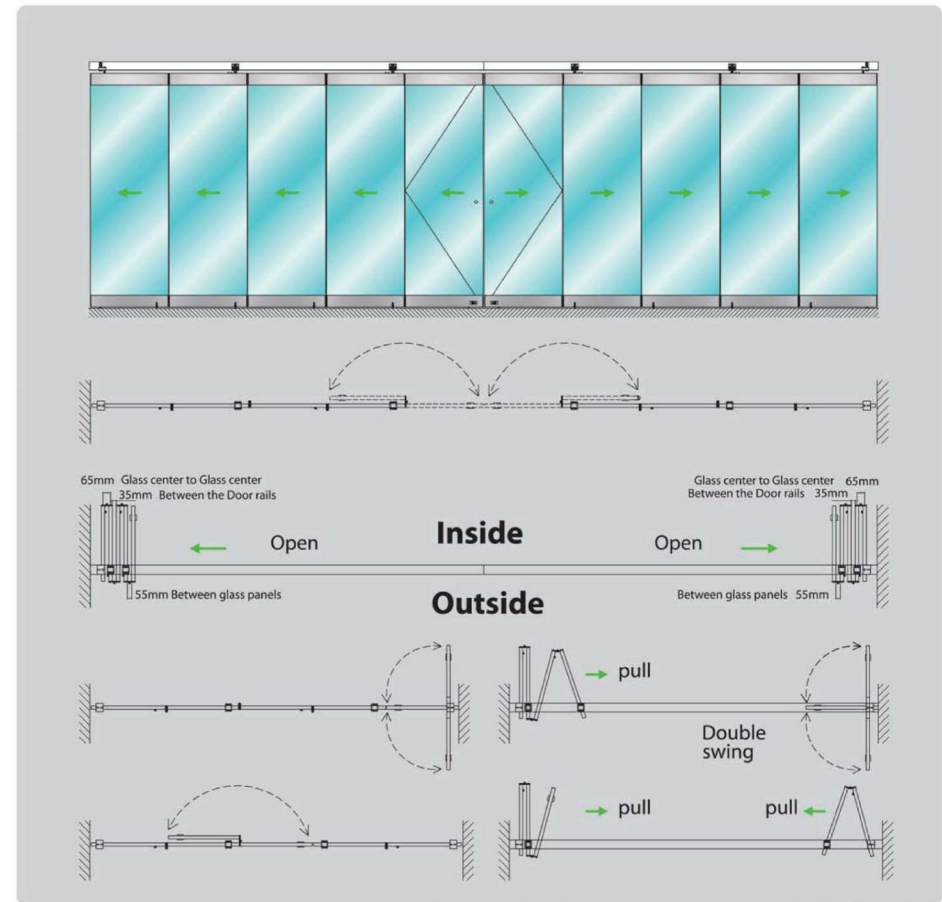
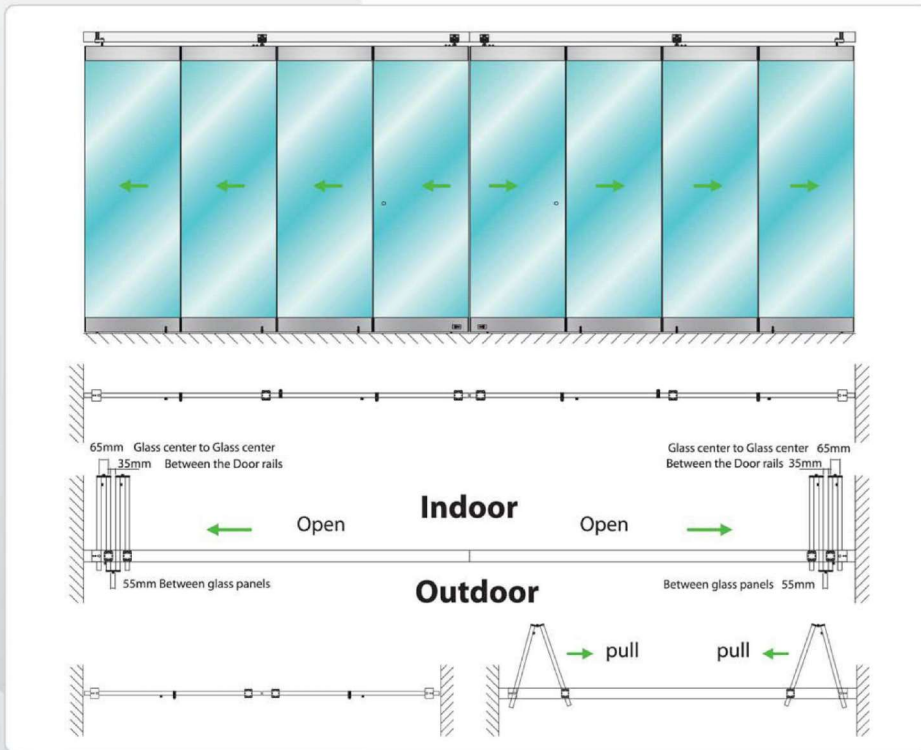

Type A1

Top: SWS 80 ST
SWS 80 TC/LP
FRH - 102
FDH - 102
EC - 102 PAA
DR - 102 AL
IC 102 - 1020 / 1030 / 1040 or
IC 102 - 1220 / 1230 / 1240

Bottom : DR-101 AL or DR-102 AL
9150
EC-102 PAA
FDH - 102
DFB 102S
9147 / DR
DRL5025 B
IC 102 - 1020 / 1030 / 1040 or
IC 102 - 1220 / 1230 / 1240

- Roller fixed offset
 - Every panel mounted to floor by flush bolt and the last panel can be locked.
 - If you **don't required** the end panel to open and close as swing door, you must order in even multiple. For example : 2,4,6,8 panels.
Max. height : 3000 mm
Max. width : 850 mm
Max. weight : 80 kgs
- Two sizes of inner clamps for fixing 10mm or 12mm thickness tempered glass.

Inner clamp for 10 mm

For 10mm Glass



Inner clamp for 12 mm

For 12mm Glass



Type A2

- Roller fixed offset
- Every panel mounted to floor by flush bolt and the last panel can be locked.
- If you **do required** the end panel to open and close as free swing door, you must order in odd multiple for example 3,5 or 7 panels.
Max. height : 3000 mm
Max. width : 850 mm
Max. weight : 80 kgs

If you require door panel wider, please refer to Type B1/B2



Type B1 *Rollers Center Type*

Type B2

Rollers Center Type with last free single swing panel

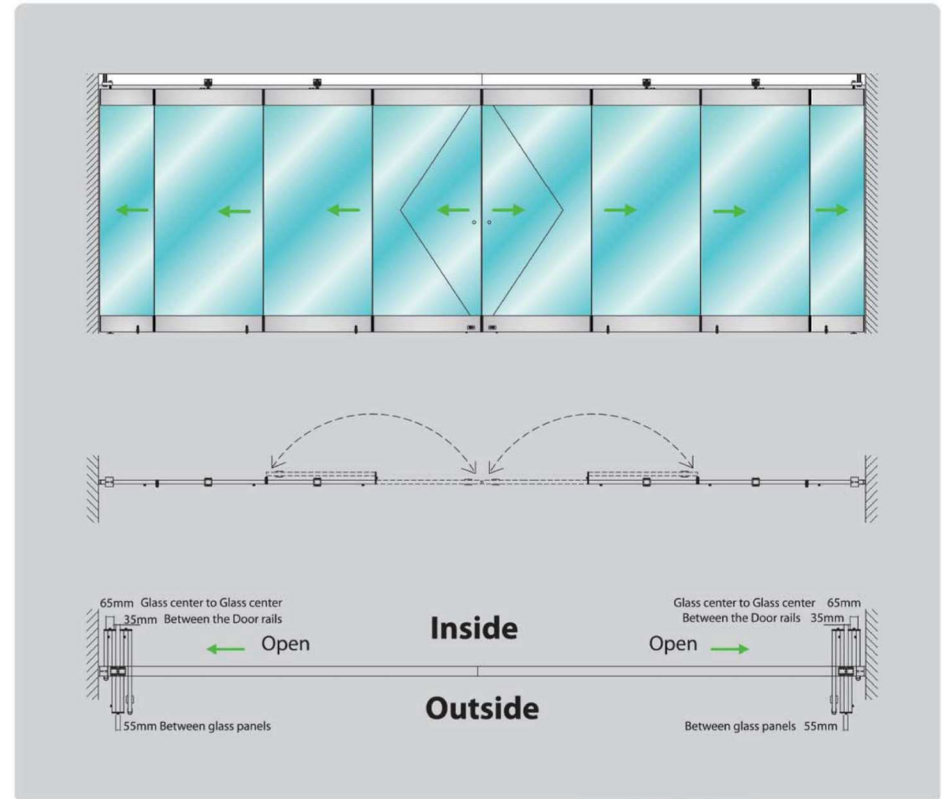
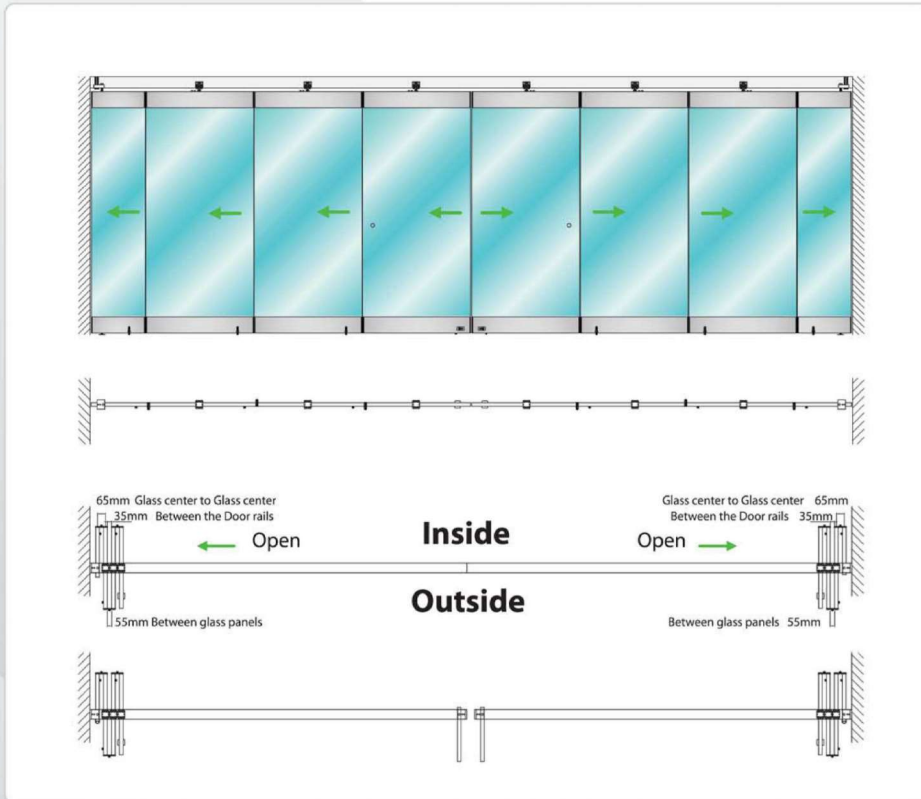

Type B1

- Every panel roller fixed in the middle
- 3~8 panels are available
- First base panel width = half panel width + (65mm±2mm)
- Max. height : 3000 mm
- Max. width : 1000 mm
- Max. weight : 80 kgs

Type B2

- Every panel roller fixed in the middle with last free panel.
- Last panel can be one side swing
- 3~8 panels are available
- First base panel width = half panel width + (65mm±2mm)
- Max. height : 3000 mm
- Max. width : 1000 mm
- Max. weight : 80 kgs



Inner Clamp

Installation Instruction

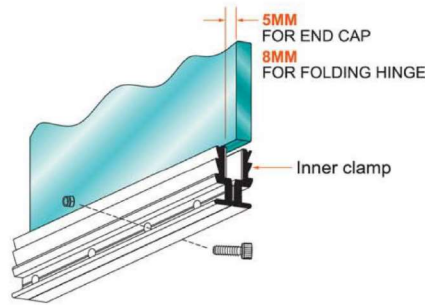
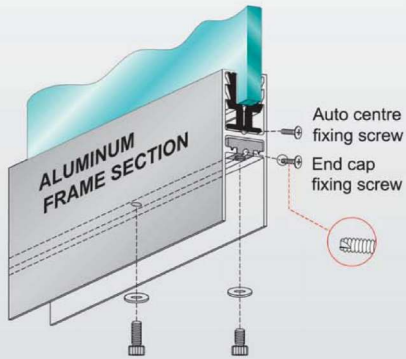

For 10mm Glass



IC102-1020 IC102-1030 IC102-1040

For 12mm Glass



IC102-1220 IC102-1230 IC102-1240

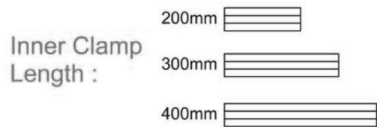

- * Clean up the glass on both edges for clamps.
- * Put the clamp on the glass and make sure edge to edge.
- * Tighten each bolts and nuts levelly.

Auto Door (Sliding Door)

* The max. space required between two inner clamps is 100mm.

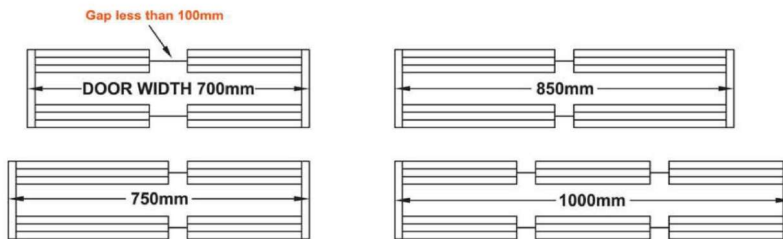

- SWS-805T**
Sliding track for rollers
- FRH-102**
The roller hanger for SFW-DR System
- Top Weather Strip 25mm**
Top : Rubber Seal in 20 mm or 25mm
Bottom : Rubber Seal in 15 mm
- 4A. DR-102**
Main section door rail for top hanging and bottom
- 4B DR-101**
Main section door rail for bottom use only
(Easy to install accessories)
- INNER CLAMP**
- FDH-102**
Folding door hinge with fixing blocks.
- DFB-102S**
Side Flush Bolt for DR - 102
- 9147/DR**
Floor Socket
- 9150**
Adjustable free pivot for first panel
- PU10/12BS**
Bubble seal plastic strip for protecting glass, and seal the gap.
- End Cap.**

* For door rail information , please refer to GCC Door Rails catalogue.

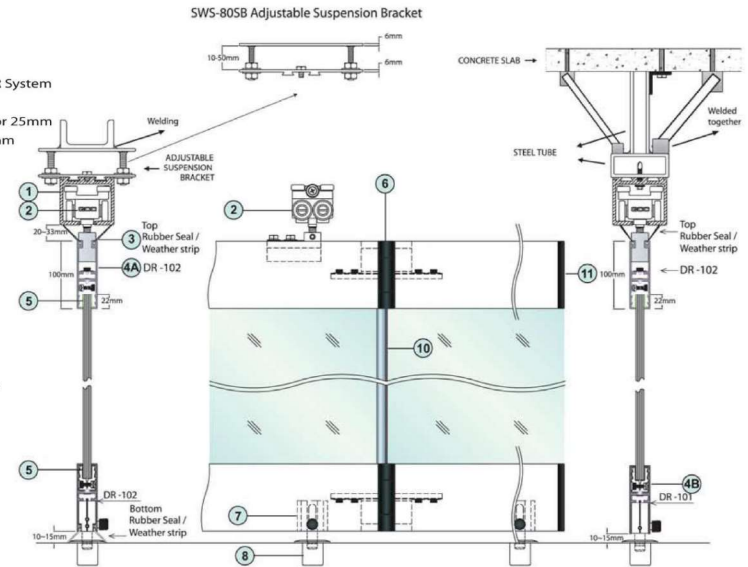

Special stacking upon requirement.

Clear PVC Seals (Optional)

"U" Jamb With Bubble

- The circulation of air between indoors and outdoors can be limited, as such, the temperature to the air-conditioned room or building is maintained, dirt and dust is prevented from entering the room or building, and the edge of the frameless door panel is also protected (Fix to single edge only).
- Supplied in 3000mm(3 meters) stock lengths.
- Snap on to the glass.

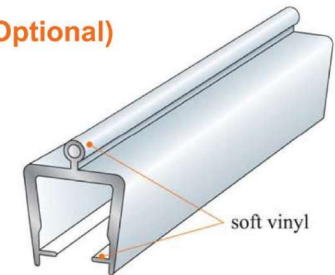

Code No.	Glass Thick
PU10BS	10mm(3/8")
PU12BS	12mm(1/2")



Accessories for SFW-DR Systems

SWS -80ST

Sliding Track

- Standard length in stock 3 meters.

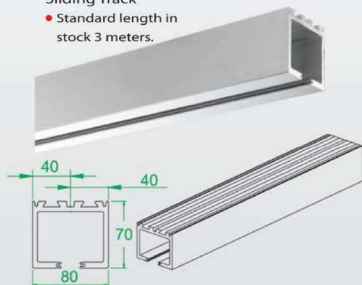

SWS -80 CNP

Connecting Pin

- For connecting both sliding tracks to level & straight.



SWS -80CNB

Connecting Bar

- For connecting both sliding tracks to level & straight.



9125DR

Europrofile cylinder

- For Fixing To DRL-5025B Door Rail Lock.



DRL-5025B

Door Rail Lock

- Fix in DR-101 or DR-102 door rail with a europrofile cylinder (#9125DR) for locking to the floor.



SWS -80 TC/LP

Top Center Pivot + Lower Part

- Fix in SWS-80ST sliding track with SWS-80LP in the door rail.



Base panel

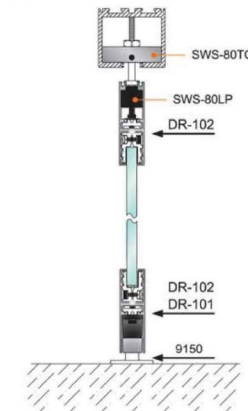

HW-001

3 Ways Hex Wrench

- 3 ways hex wrench with size no. 4.5,6 three sizes to tighten/loosen hex socket screws of SFW system, SWS system, inner clamps...etc.



FRH -102

Folding Door Roller Hanger

- Fix in DR-102 door rail for sliding door panel.



SWS-80SB

Adjustable Suspension Bracket

- Fix in DR-102 door rail for sliding door panel.



9147 / DR

Floor Socket

- Fix in the floor for DFB flush bolts & floor rail locks (DRL-5025B)



SWS -80EST

End Stopper

- Fix in SWS-80ST for stopping sliding doors.



FDH-102

Folding door hinge with fixing blocks.



9150

Adjustable free pivot

- Fix to floor and special arm for fix to DR-101 or DR-102 door rail.
- Height adjustable.



DFB -102S

Side flush Bolt

- Fix in DR-101 or DR-102 door rail for locking to the floor with a side knob.



EC 102PAA

End Cap

- For regular DR-101, DR-102 door rail both end use.



SQ50

25mm Brush

SQ50S

10mm Brush

Weather Strip

- Fix in DR-102 door rail.
- To keep dust out and aircondition inside.



150 meters/per roll

RS-1050

10mm Rubber

RS-1550

15mm Rubber

RS-2050

20mm Rubber

RS-2550

25mm Rubber

Rubber Strip

- Fix in DR-102 door rail.
- To keep dust out and aircondition inside.



50 meters/per roll

We Love Hardware



**Admin & Hardware
Distribution**
170 Derrimut Drive
Derrimut VIC 3026

Custom Fabrication
144 Derrimut Drive
Derrimut VIC 3026

SA Distribution
7 Manfulll Street
Melrose Park SA 5039

1300 4 ELITE